



Ocean

# Ocean



# SPARCRAFT

# mâts



## Gamme OCEAN line

OCEAN est une gamme complète de mâts traditionnels et à enrouleur, qui s'adaptent à tous les bateaux de croisière de grande série en navigation côtière ou océanique.

  OCEAN is a full range of standard and furling masts to suit all production cruising yachts from coastal cruisers to blue water offshore passage makers

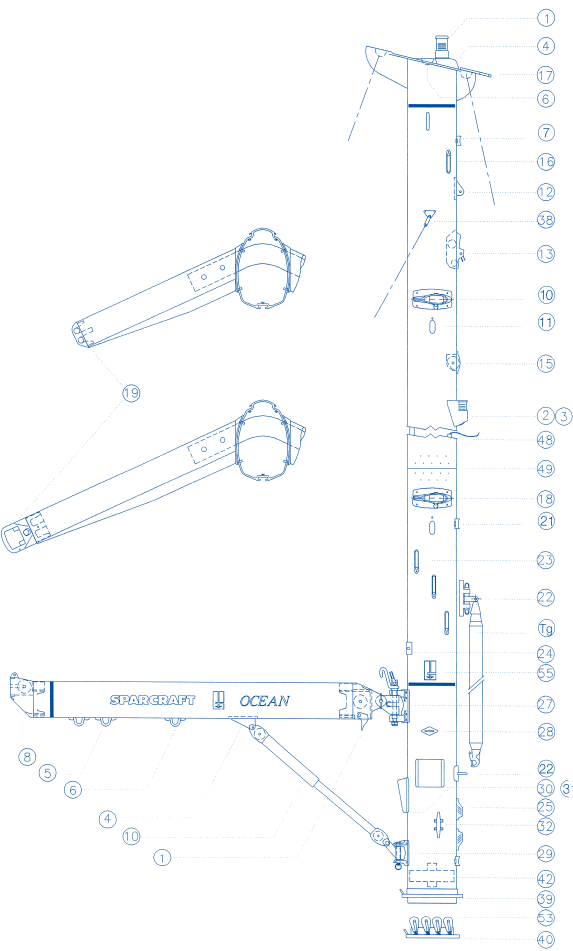















### MÂT MAST

- 1 - Feu de tête de mât Mast head light
- 2 - Feu de route Steaming light
- 3 - Feu de pont Deck light
- 4 - Tête de mât Mast head
- 6 - Accrochage galhauban Upper shrouds attachment
- 9 - Accrochage haubans Shrouds attachment
- 12 - Accrochage étai largable Inner forestay attachment
- 13 - Capelage étai Forestay equipment
- 15 - Boîte à réa Sheave box
- 16 - Entrée de spi Internal spi (entry)
- 17 - Ferrure de spi External spi attachment
- 18-10 - Ensemble barres de flèche Spreaders set
- 19 - Embouts barres de flèche Spreader tips
- 22 - Chariot de tangon Spi equipment
- 23 - Sorties de drisse Halyard exits
- 24 - Porte de grand-voile Sail gate
- 25 - Clam-cleat Clam-cleat
- 27 - Vit de mulet Goosneck attachment
- 28 - Anneau jockey pole Pad eyes
- 29 - Ferrure de halebas Articulated kicker
- 30-31 - Platines de winch Winch pads
- 32 - Taquets Cleats
- 22 - Anneau de tangon Spi eye
- 7 - Filoir Fairlead
- 38 - Ancrage à lattes External tangs
- 39 - Colerette de mât Deck collar
- 40 - Pied de mât Mast step
- 42 - Bouchon d'étanchéité intérieure Internal water-proofing
- 48 - Fils et tubes électriques Electrical conduits and wires
- 49 - Manchons internes Internal splices
- 53 - Poulies Blocks
- 55 - Autocollants Stickers

### BÔME BOOM

- 1 - Embout de bôme avant Inboard end
- 3 - Vit de mulet complet Complete goosneck
- 4 - Ferrure de halebas Kicker attachment
- 5 - Accrochage d'écoute Main sheet attachment
- 6 - Accrochage de ris Reefs attachment
- 8 - Embout de bôme arrière Outboard end
- 10 - Halebas poussant Rod kicker

### 1 - Tg TANGON POLE

Dimensions (mm)	IXX' (Cm4)	IYY' (Cm4)	Poids (Kg/M) Weight
 68 x98	35	70	1,7
 74 x108	50	100	2,1
 82 x118	67	128	2,2
 96 x132	101	208	2,5
 98 x145	137	306	3,1
 104 x159	174	405	3,4
 115 x170	257	585	4,2
 120 x180	325	742	4,8
 125 x190	405	830	5,3
 137 x205	530	1100	5,9
 145 x220	665	1430	7,0
 155 x230	830	1780	7,7
 172 x248	1050	2150	8,8
 182 x283	1552	3232	10,1

# Masts



- Aluminium de première fusion
- Protection par anodisation
- Une gamme très complète d'éléments standards et optionnels



- Primary foundry alloy
- Anodized protection
- A full range of standard and optional parts



Ocean

# Gamme Ocean line

# SPARCRAFT

## Profils Ocean / Ocean sections

■ Les profils de la gamme Ocean sont adaptées aux petites et moyennes unités, des plus anciennes aux plus récentes.

■ Ocean series sections are suitable for small and medium boats, from the original equipment to the current ones.

## Têtes de mât / Mastheads

■ Différents modèles sont disponibles suivant vos besoins : moulés, extrudés, avec ou sans rétreint, diverses options de réas,...

■ Different models are available, according to your sailing needs : cast, extruded, tapered or non-tapered. There are also sheaves options,...

## Barres de flèche / Spreaders

■ Les sections de barres de flèches sont anodisées incolores, rétreintes et usinées à longueur avec des angles de 0 à 30 degrés

■ Our standard spreaders are clear anodized and tapered. Sweep angles vary from 0 to 30 degrees.

## Equipement / Equipment

■ Sparcraft dispose de plus de 12000 références : taquets, supports de winch, équipements de spi, barreaux et embouts de barres de flèche, etc...

■ More than 12,000 Sparcraft parts are available to meet your needs : cleats, winch pads, spinnaker gear, tips or thru-bars of spreaders...



## Conçus pour durer

### Designed for Life

■ La conception des éléments de la gamme Ocean prend en compte la simplicité du montage, le coût final, la solidité ainsi qu'une grande fonctionnalité de toutes les pièces, adaptables sur différents modèles : Isomât, Francespar,...

■ The Ocean series is designed with basic fittings for, low cost, strength, as well as making the components suitable for models of : Isomat, Francespar, ...



## Fabrication / Manufacturing

■ La gamme Ocean est composée de pièces de production de grandes série assurant notre compétitivité, et réalisées à partir d'alliage à très haute résistance, garantissant ainsi une grande longévité.

■ All the parts of the Ocean series are mass produced which makes us competitive. They are made of high resistance alloy : a guaranty of reliability.



## Garantie / Warranty

■ Tous nos produits sont couverts par une garantie d'un an conformément à nos conditions générales de vente.

■ All our products have a one year warranty.

## Ocean References

■ De grandes séries sont équipés en gréements Ocean :

■ Mass series are equipped with Ocean riggings: Comet, Dufour, Feeling, First, Gibsea, Hanse, Oceanis, Sun odyssey, Sun Bean, Spirit, Winner, Catamarans / Multihulls,...

